

## Data sheet | Item number: 221-415

COMPACT Splicing Connector; for all conductor types; max. 4 mm<sup>2</sup>; 5-conductor; with levers; transparent housing; Surrounding air temperature: max 85°C (T85); 4,00 mm<sup>2</sup>; transparent

[www.wago.com/221-415](http://www.wago.com/221-415)

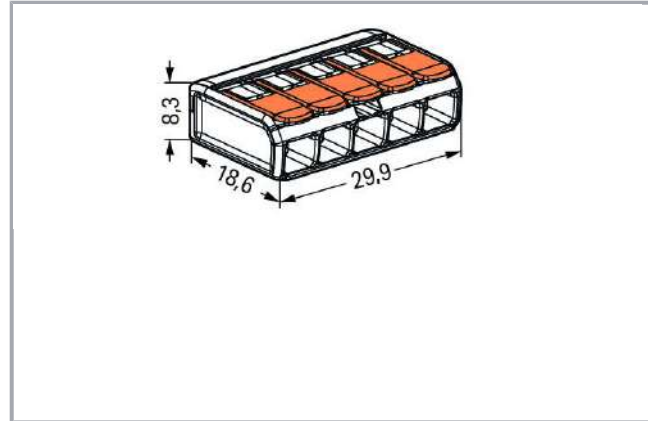

RoHS   
Compliant

BOMcheck.net



### Item description

Your Benefits:

- Ease of use – pull the lever up, insert a conductor and push the lever back down
- Available as 2-, 3- and 5-wire connectors
- Easily terminate conductors from 0.14 to 4 mm<sup>2</sup>

Sujeto a cambios. Por favor, observe también la documentación adicional de productos.

WAGO Kontakttechnik GmbH & Co. KG  
Hansastr. 27  
32423 Minden  
Phone: +49571 887-0 | Fax: +49571 887-169  
Email: [info.de@wago.com](mailto:info.de@wago.com) | Web: [www.wago.com](http://www.wago.com)

Do you have any questions about our products?  
We are always happy to take your call at +34 916 621 362.



- Connect solid, stranded and fine-stranded conductors
- Time savings for installers and device manufacturers
- Quickly install devices with higher levels of power consumption
- Safely install long cable runs with larger conductor cross sections
- Mounting carrier for installation conforms to standards
- Custom carriers are possible

**Nota de seguridad 1:**

en redes con toma de tierra

**Data****Datos eléctricos****Ratings per IEC/EN 60664-1**

Datos asignados según	EN 60664
Tensión asignada (II / 2)	450 V
Tensión de choque asignada (II / 2)	4 kV
Corriente asignada	32 A
Leyenda datos asignados	(II / 2) $\triangle$ Overvoltage category II / Pollution degree 2

**Approvals per UL 1059**

Tensión asignada UL (Use Group C)	600 V
Corriente asignada según UL (Use Group C)	20 A

**Datos de conexión**

Tipo de conexión	CAGE CLAMP® (CLEMA CEPO)
Tipo de accionamiento	Tecla de accionamiento
Materiales de conductor conectables	Cobre
Sección nominal	4 mm <sup>2</sup>
Conductor rígido	0,2 ... 4 mm <sup>2</sup> / 24 ... 12 AWG
Conductores semi-rígidos	0,2 ... 4 mm <sup>2</sup> / 24 ... 12 AWG
Conductor flexible	0,14 ... 4 mm <sup>2</sup> / 24 ... 12 AWG
Longitud de pelado	11 mm / 0.43 inch
Número total de puntos de conexión	5
Número total de potenciales	1
Tipo de cableado	conexión lateral

Sujeto a cambios. Por favor, observe también la documentación adicional de productos.

WAGO Kontakttechnik GmbH & Co. KG  
 Hansastr. 27  
 32423 Minden  
 Phone: +49571 887-0 | Fax: +49571 887-169  
 Email: [info.de@wago.com](mailto:info.de@wago.com) | Web: [www.wago.com](http://www.wago.com)

Do you have any questions about our products?  
 We are always happy to take your call at +34 916 621 362.

## Datos geométricos



Ancho	29,9 mm / 1.177 inch
Altura	8,3 mm / 0.327 inch
Profundidad	18,6 mm / 0.732 inch

## Datos de materiales



Color	transparente
Clase de inflamabilidad según UL 94	V2
Color del elemento accionador	naranja
Peso	4 g

## Certificados/homologaciones

### Country specific Approvals

Logotipo	Homologación	Texto de aprobación adicional	Nombre de certificación
	CCA DEKRA Certification B.V.	EN 60998	NTR NL-7642
	CCA DEKRA Certification B.V.	EN 60998	71-101731



### Ship Approvals

Logotipo	Homologación	Texto de aprobación adicional	Nombre de certificación
	ABS American Bureau of Shipping	-	18-HG1755093-PDA
	DNV GL Det Norske Veritas, Germanischer Lloyd	EN 60998	TAE000015T
	LR Lloyds Register	EN 60998	04/20013 (E8)

### UL-Approvals

Sujeto a cambios. Por favor, observe también la documentación adicional de productos.



Logotipo	Homologación	Texto de aprobación adicional	Nombre de certificación
	UL Underwriters Laboratories Inc.	UL 467	E201573
	UL Underwriters Laboratories Inc.	UL 486C	E69654

Sujeto a cambios. Por favor, observe también la documentación adicional de productos.

WAGO Kontakttechnik GmbH & Co. KG  
Hansastr. 27  
32423 Minden  
Phone: +49571 887-0 | Fax: +49571 887-169  
Email: [info.de@wago.com](mailto:info.de@wago.com) | Web: [www.wago.com](http://www.wago.com)

Do you have any questions about our products?  
We are always happy to take your call at +34 916 621 362.